

MEDİKAL

TEKERLEKLER





HAKKIMIZDA

EMES A.Ş. 1998 yılında Türkiye ve Dünya pazarlarında ticaret yapan saygın kuruluşların iştiraki ile çok ortaklı bir şirket olarak kurulmuştur. Kısa bir süre içerisinde Türkiye ve Dünya pazarlarında güçlü bir marka olarak kendini kabul ettirmiştir. Kuruluşundan bugüne kadar geçen süre içerisinde standart seri ürün yelpazesini 9.000 çeşidin üzerine çıkarma başarısını göstermiş ve ulaştığı yüksek kalite düzeyi ile iç ve dış pazarlarda rekabet edebilir hale gelmiştir. Vizyonunu sürekli kendini yenileyen dinamik yapısı ile ulusal ve küresel pazarlarda ilk ve en çok tercih edilen kaliteli ve güvenilir marka olarak belirleyen EMES A.Ş., Türkiye genelinde yaygın bayilik ağı ve yurtdışındaki geniş satış ağı ile başta Avrupa olmak üzere Ortadoğu, Afrika, Balkanlar ve Orta Asya'da yer alan 67'nin üzerindeki ülkeye ihracat gerçekleştirmektedir.

EMES A.Ş. yaklaşık 10.000 m² lik kapalı alan üzerine kurulu modern tesislerinde eğitimli teknik kadrosu ile gerçekleştirdiği üretiminde, şirketin kalite politikasının da bir parçası haline gelen mutlak müşteri memnuniyetini hedefleyerek çalışmaktadır. Türkiye ve dünya çapındaki kalitesi, dinamik ve yaratıcı personeli ile EMES A.Ş. kendine has insan kaynağı oluşturmuştur. Türkiye'de kendi sektöründe DIN EN ISO 9001:2015 belgesine sahip ilk firmadır. Misyonunu; sektörel gelişimleri yakından takip ederek bunları kalite politikasının birer parçası haline getirmek sürekli müşteri memnuniyetini hedefleyerek çalışanları ile birlikte daha güvenilir, kaliteli ve estetik tasarımlı ürünleri müşteriye sunmak olarak belirlemiştir. Türkiye'de ve dünyada yer alan müşterilerine bulunduğu sektöre özgü çözüm ve hizmetler sunmaktadır.

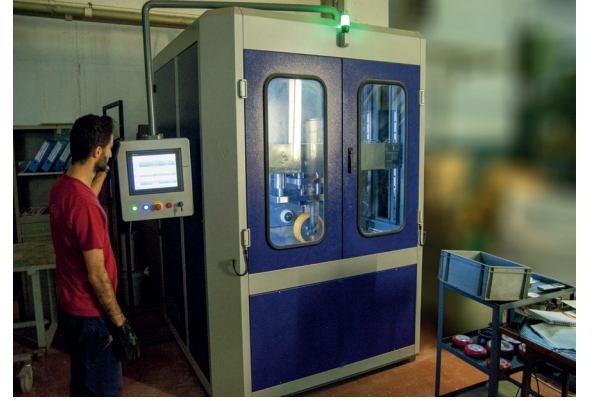

ÜRÜN KODLAMA SİSTEMİ

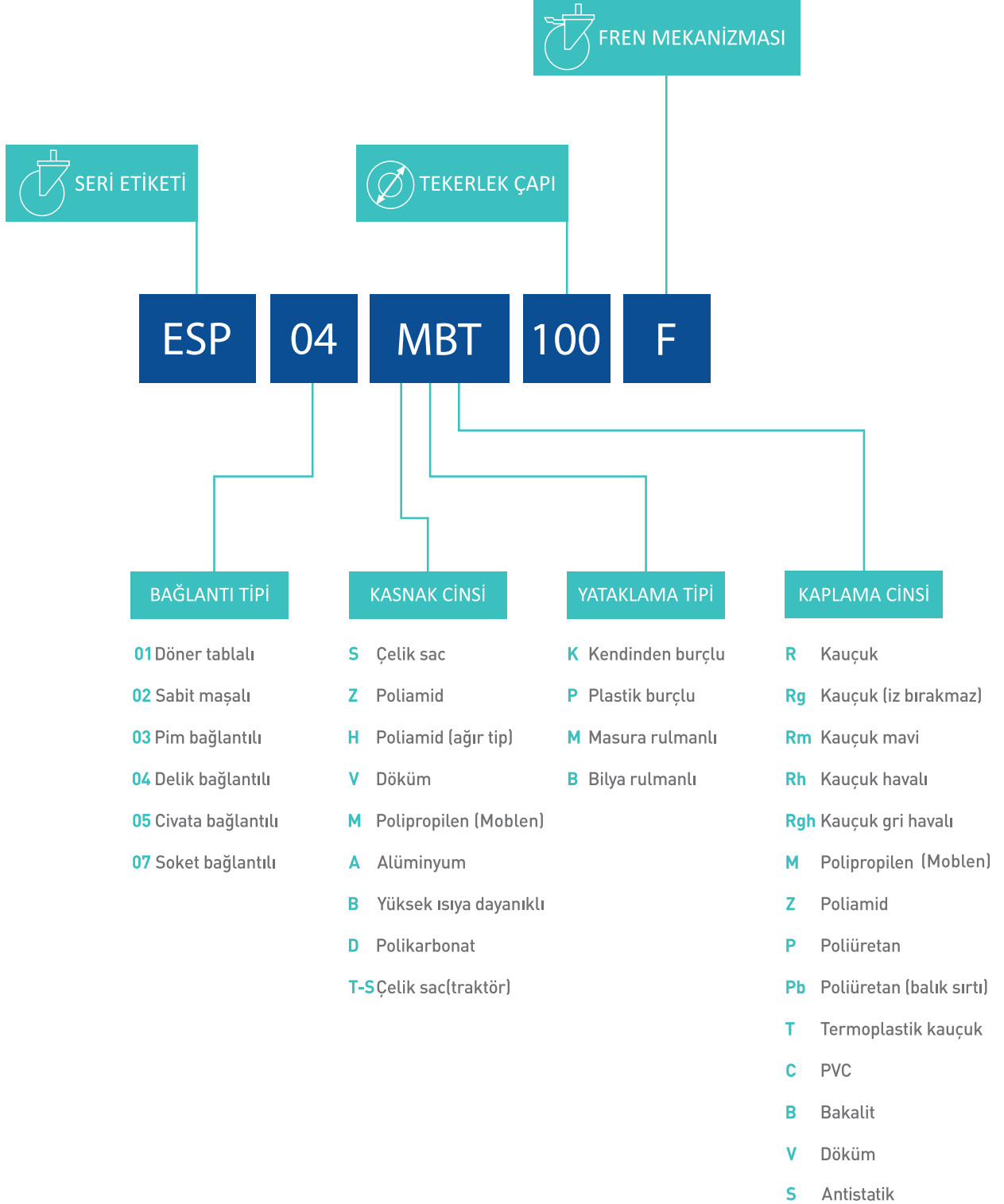

BAĞLANTI TİPLERİ



Tabla Bağlantı:

Genellikle taşıma arabası tekerleklerinde ve ağır hizmet tiplerinde tercih edilen bağlantı tipidir. Tekerlek, civata ve somun aracılığıyla oynak tablaya bağlantı yapılarak yüzeye montaj gerçekleştirilir.

Dikkat edilmesi gereken hususlar: Tablanın ebatları, tablanın delik merkezleri, tabla delik çapı



Pim Bağlantı:

Genellikle hafif hizmet tipi tekerleklerde ve taşıma arabaları tekerleklerinde tercih edilen bağlantı tipidir. Tekerlek bağlanacak yüzeydeki deliğe pim yardımıyla montajı gerçekleştirilir.

Dikkat edilmesi gereken hususlar: Pim çapı, pim uzunluğu



Delik Bağlantı:

Genellikle hafif hizmet tipi tekerleklerde ve taşıma arabaları tekerleklerinde tercih edilen bağlantı tipidir. Tekerlek döner başlığın ortasındaki delikten seyyar bir civata ile montajı gerçekleştirilir.

Dikkat edilmesi gereken hususlar: Delik çapı



Civata Bağlantı:

Genellikle hafif hizmet tiplerinde tercih edilen bağlantı tipidir. Tekerlek bağlanacak yüzeydeki deliğe civata geçirilerek somuna vidalanarak montajı gerçekleştirilir.

Dikkat edilmesi gereken hususlar: Civata çapı, civata boyu



Soket Bağlantı:

Soket bağlantı tipi genellikle hafif hizmet tiplerinde tercih edilen bağlantı tipidir. Tekerlek bağlanacak boruya veya profile takılan plastik genişletme soketi aracılığıyla montajı gerçekleştirilir

Dikkat edilmesi gereken hususlar: Boru biçimi: yuvarlak veya köşe profil, boru iç çapı

Semboller

Katalogta yer alan semboller ařađıda gsterilmektedir.

				
rn kodu	Pim/Civata apı	Tabla ebatları	Jant kapađı	Mařa kalınlıđı
				
Tekerlek apı	Delik apı	Delik mesafesi	Tekerlek yatađı	Tařıma kapasitesi
				
Tekerlek geniřliđi	Pim/Civata boyu	Tabla delik apı	Tekerlek ađırlıđı	Porya delik apı
				
Tm ykseklik	Tabla kalınlıđı	Porya uzunluđu	Toplam ađırlık	Sac kalınlıđı

(-): Jant kapađı yok

(+): Tercihe bađlı

(S): Standart

Tm uzunluklar : (mm)

rn ađırlıđı : (gr)

Tařıma kapasitesi : (kg) olarak belirtilmiřtir.

Tekerlek Yataklama Tipleri



Bilya Rulman Yataklı

Ağır yükler için ve yüksek hızlarda hareket eden araçların tekerleklerinde kullanılması tavsiye edilir. Darbelere karşı dayanıklı, kolay ve sessiz hareket edebilme kabiliyeti vardır. Taşıma ve hareket hızı yüksek araçlarda da en yüksek ihtiyaçlara cevap verebilmesi açısından en ideal yataklama tipidir. Bilya rulmanlar yataklama, boşluğu en az rulman tipi olup normal şartlarda uzun ömürlü ve bakım gerektirmeyen yataklama tipidir. Paslanmaz bilya rulman modelleride mevcuttur.



Masura Rulman Yataklı

Hafif yükler için ve düşük hızlarda hareket edecek araçlardaki tekerleklerde kullanılır. Darbelere ve suya karşı dayanıklı, sağlam ve gres yağı ile yağlandıklarından dolayı normal kullanım şartlarında özel bakım gerektirmeyen bir yataklama türüdür. Taşıma kapasitesi ve hareket etme kabiliyetleri göz önüne alındığında, bilya rulman yataklarına göre daha hafif ve düşük hızlarda hareket eden araçların tekerleklerinde kullanılır. Paslanmaz masura rulman modelleride mevcuttur.



Kendinden Burçlu Yataklı

Hafif yükler için ve düşük hızlarda hareket edecek araçlardaki tekerleklerde kullanılır. Darbelere ve suya karşı dayanıklı, hassas olmayan, özel bakım gerektirmeyen, ekonomik bir yataklama türüdür.



Taşıma Kapasitesini Belirleme

Bir tekerleğin taşıma kapasitesi taşıma arabasının kendi ağırlığı ve üzerine konulacak yükün toplamının teker sayısına bölünmesiyle hesaplanır.

Taşıma Kapasitesi

Uygun taşıma kapasitesine sahip tekerleği seçebilmek için yandaki formül kullanılabilir.

$$K = \frac{B+Y}{T} \times E$$

K: Seçilecek tekerleğin minimum taşıma kapasitesi

B: Uygulama aracının boş ağırlığı (dara)

Y: Taşınacak yükün ağırlığı

T: Uygulama aracına bağlanacak tekerlek sayısı

E: Emniyet çarpanı (1,5<E<2,0)

Daha basit yöntem ise, dolu araç ağırlığını gerçekte bağlanacak tekerlek sayısının bir eksiğine bölerek tekerlek başına düşen minimum taşıma kapasitesini bulmaktır. Bunun içinde aşağıdaki formül kullanılabilir.

$$K = \frac{\text{Toplam Ağırlık}}{\text{Tekerlek Sayısı}-1}$$

Yataklama Tipi Seçimi

Yataklama tipi belirlenirken; taşınacak yük miktarı, tekerleği hareket ettirmek için uygulanacak kuvvet ve tekerleğin kullanılacak çevre faktörleri dikkate alınarak belirlenmelidir.

ECH SERİSİ

Taşıma kapasitesi 150 Kg

Maşa: Plastik gövdeli maşa, gri (RAL 9002), çift bilya yataklı, döner başlık, perçinli teker aksı

Teker: Polipropilen kasnak, termoplastik kauçuk kaplama, plastik kapaklı, bilya rulman yataklı

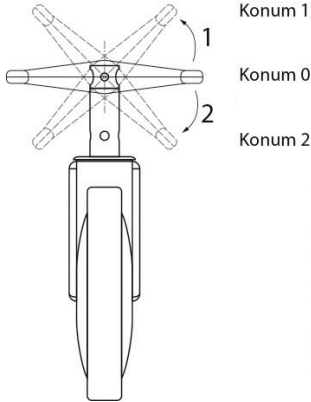



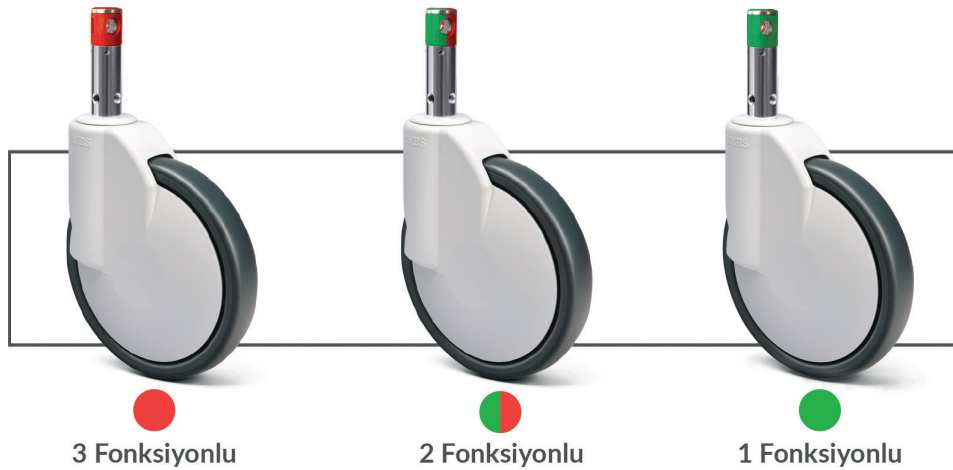





	3 Fonksiyonlu			2 Fonksiyonlu			1 Fonksiyonlu		
	Yön Kilit	Frensiz	Teker Kilit	Yön Kilit	Frensiz	Teker Kilit	Yön Kilit	Frensiz	Teker Kilit
Konum 1	+				+			+	
Konum 0		+			+			+	
Konum 2	+		+	+		+		+	













Pim bağlantılı, frenli

									
	mm	mm	mm	mm	mm	mm	mm	gr	kg
ECH 03 MBT 125 F	125	32	159	32	50	40	2,5	992	150
ECH 03 MBT 150 F	150	32	183	32	50	38	2,5	1135	150
ECH 03 ZBP 200 F	200	32	226	32	50	60	3	1427	150

Yön Kilitli 
Merkezden frenli tekerlek











Pim bağlantılı, frenli

									
	mm	mm	mm	mm	mm	mm	mm	gr	kg
ECH 03 MBT 125 F	125	32	159	32	50	40	2,5	992	150
ECH 03 MBT 150 F	150	32	183	32	50	38	2,5	1135	150
ECH 03 ZBP 200 F	200	32	226	32	50	60	3	1427	150

Merkezden Frenli 
Merkezden frenli tekerlek
tam ya da yön kilitli











Pim bağlantılı

									
	mm	mm	mm	mm	mm	mm	mm	gr	kg
ECH 03 MBT 125	125	32	159	28	41	40	2,5	980	150
ECH 03 MBT 150	150	32	183	28	41	38	2,5	1122	150
ECH 03 ZBP 200	200	32	226	28	41	60	3	1408	150

Frensiz 
Dönerli tekerlek











Pim bağlantılı, frenli

									
	mm	mm	mm	mm	mm	mm	mm	gr	kg
ECH 03 MBT 125 F	125	32	159	28	94	40	2,5	1080	150
ECH 03 MBT 150 F	150	32	183	28	94	38	2,5	1225	150
ECH 03 ZBP 200 F	200	32	226	28	94	60	3	1537	150

Merkezden Frenli 
Merkezden frenli tekerlek
tam ya da yön kilitli



Pim bağlantılı, frenli

									
	mm	mm	mm	mm	mm	mm	mm	gr	kg
ECH 03 MBT 125 F	125	32	159	28	94	40	2,5	1080	150
ECH 03 MBT 150 F	150	32	183	28	94	38	2,5	1225	150
ECH 03 ZBP 200 F	200	32	226	28	94	60	3	1537	150

Yön Kilitli 
Merkezden frenli tekerlek

EC SERİSİ

 Taşıma kapasitesi 90 Kg

 **Maşa:** Plastik gövdeli maşa, gri (RAL 9002), çift bilya yataklı, döner başlık, perçinli teker aksı

 **Teker:** Polipropilen kaskak, termoplastik kauçuk kaplama, plastik kapaklı, bilya rulman yataklı

 **Bağlantı Tipleri:** Tabla bağlantılı, pim bağlantılı, delik bağlantılı, civata bağlantılı, soket bağlantılı





















Tabla Bağlantılı	 mm	 mm	 mm	 mm	 mm	 mm	 gr	 kg	
EC 01 MBT 100	100	32	138	78x68	56x46	5,7	538	80	S
EC 01 MBT 125	125	32	165	78x68	56x46	7,5	764	90	S



Tabla Bağlantılı, frenli	 mm	 mm	 mm	 mm	 mm	 mm	 gr	 kg	
EC 01 MBT 100 F	100	32	138	78x68	56x46	5,7	586	80	S
EC 01 MBT 125 F	125	32	165	78x68	56x46	7,5	816	90	S

ESP SERİSİ

- 📦 Taşıma kapasitesi 100 Kg
- 🔧 **Maşa:** Plastik gövdeli maşa, gri (RAL 9002) veya siyah renk alternatifli, çift bilya yataklı döner başlık, perçinli teker aksı
- 🔸 **Teker:** Polipropilen kasnak, plastik jant kapaklı, bilya rulman yataklı, termoplastik kauçuk kaplama
- 🔸 **Bağlantı Tipleri:** Tabla bağlantılı, delik bağlantılı





























Tabla Bağlantılı	 mm	 mm	 mm	 mm	 mm	 mm	 gr	 kg	
ESP 01 MBT 100	100	32	140	68x78	46x56	7	547	90	S
ESP 01 MBT 125	125	32	169	68x78	46x56	7	658	100	S











Tabla Bağlantılı, Frenli	 mm	 mm	 mm	 mm	 mm	 mm	 gr	 kg	
ESP 01 MBT 100 F	100	32	140	68x78	46x56	7	581	90	S
ESP 01 MBT 125 F	125	32	169	68x78	46x56	7	696	100	S









Pim Bağlantılı	 mm	 mm	 mm	 mm	 mm	 mm	 gr	 kg	
ESP 03 MBT 100	100	32	137	22	42	7	574	90	S
ESP 03 MBT 125	125	32	167	22	50	7	680	100	S









Pim Bağlantılı, Frenli	 mm	 mm	 mm	 mm	 mm	 mm	 gr	 kg	
ESP 03 MBT 100 F	100	32	137	22	42	7	608	90	S
ESP 03 MBT 125 F	125	32	167	22	50	7	723	100	S











Delik Bağlantılı	 mm	 mm	 mm	 mm	 gr	 kg	
ESP 04 MBT 100	100	32	137	10-12	409	90	S
ESP 04 MBT 125	125	32	166	10-12	525	100	S











Delik Bağlantılı, Frenli	 mm	 mm	 mm	 mm	 gr	 kg	
ESP 04 MBT 100 F	100	32	137	10-12	443	90	S
ESP 04 MBT 125 F	125	32	166	10-12	563	100	S



Civata Bağlantılı	 mm	 mm	 mm	 mm	 mm	 mm	 gr	 kg	
ESP 05 MBT 100	100	32	143	M16-5/8	30	7	502	90	S
ESP 05 MBT 125	125	32	173	M16-5/8	30	7	610	100	S



Civata Bağlantılı, Frenli	 mm	 mm	 mm	 mm	 mm	 mm	 gr	 kg	
ESP 05 MBT 100 F	100	32	143	M16-5/8	30	7	540	90	S
ESP 05 MBT 125 F	125	32	173	M16-5/8	30	7	651	100	S

EQ SERİSİ

- 📦 Taşıma kapasitesi 50 Kg
- 🔧 **Maşa:** PP kasnak TPE kaplama veya PA kasnak TPU kaplama, polipropilen veya poliamid gövde
- 🔸 **Teker:** Poliamid kasnak, termoplastik poliüretan kaplama kendinden burçlu yataklı
- 🔸 **Bağlantı Tipleri:** Tabla bağlantılı, civata bağlantılı

































Tabla Bağlantılı	 mm	 mm	 mm	 mm	 mm	 mm	 mm	 gr	 kg	
EQ 01 ZKP 50	50	10	47	50x50	38x38	68	18	119	40	-
EQ 01 ZKP 75	75	10	55	65x65	45x45	93	22	265	50	-
EQ 01 ZBP 100	100	15	64	65x65	45x45	127	31	525	110	-













Tabla Bağlantılı, frenli	 mm	 mm	 mm	 mm	 mm	 mm	 mm	 gr	 kg	
EQ 01 ZKP 50 F	50	10	47	50x50	38x38	68	18	125	40	-
EQ 01 ZKP 75 F	75	10	55	65x65	45x45	93	22	279	50	-
EQ 01 ZBP 100 F	100	15	64	65x65	45x45	127	31	545	110	-



Pim bağlantılı	 mm	 mm	 mm	 mm	 mm	 mm	 mm	 gr	 kg	
EQ 05 ZKP 50	50	10	47	M8-5/16	18	63	15	83	40	-
EQ 05 ZKP 75	75	10	55	M10-3/8	22	85	15	197	50	-
EQ 05 ZBP 100	100	15	64	M12	31	120	20	465	110	-



Pim bağlantılı, frenli	 mm	 mm	 mm	 mm	 mm	 mm	 mm	 gr	 kg	
EQ 05 ZKP 50 F	50	10	47	M8-5/16	18	63	15	89	40	-
EQ 05 ZKP 75 F	75	10	55	M10-3/8	22	85	15	208	50	-
EQ 05 ZBP 100 F	100	15	64	M12	31	120	20	485	110	-

ER SERİSİ

- 📦 Taşıma kapasitesi 150 Kg
- 🔧 **Maşa:** Çelik sacdan üretilmiş çinko kaplamalı oynak maşa. Darbe dayanımlı yüksek performanslı plastikten üretilmiş yan ve üst kapaklar
- 🔍 **Teker:** Bozuk zeminlere dayanıklı polipropilen kasnaklı termoplastik kaplamalı tekerlek
- 🔗 **Bağlantı Tipleri:** Tabla bağlantılı, sabit bağlantılı, pim bağlantılı, delik bağlantılı, civata bağlantılı, soket bağlantılı



TEKER TİPLERİ



Tabla Bağlantılı	Ø mm	mm	mm	mm	mm	mm	gr	kg	⊙
ER 01 MBT 80	80	32	114	78x68	56x46	2,5	607	75	S
ER 01 MBT 100	100	32	136	78x68	56x46	2,5	665	80	S
ER 01 MBT 125	125	32	160	78x68	56x46	2,5	775	90	S
ER 01 MBT 150	150	32	183	78x68	56x46	2,5	1075	110	S
ER 01 MBT 200	200	32	237	78x68	56x46	2,5	1360	150	S



Tabla Bağlantılı, frenli	Ø mm	mm	mm	mm	mm	mm	gr	kg	⊙
ER 01 MBT 80 F	80	32	114	78x68	56x46	2,5	755	75	S
ER 01 MBT 100 F	100	32	136	78x68	56x46	2,5	810	80	S
ER 01 MBT 125 F	125	32	160	78x68	56x46	2,5	935	90	S
ER 01 MBT 150 F	150	32	183	78x68	56x46	2,5	1184	110	S
ER 01 MBT 200 F	200	32	237	78x68	56x46	2,5	1287	150	S

EP SERİSİ

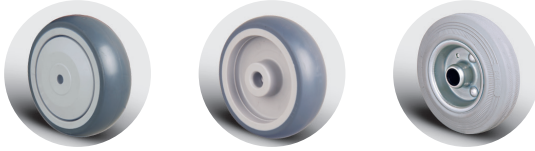
- 📦 Taşıma kapasitesi 50 Kg
- 🔧 **Maşa:** Preslenmiş çelik sac, beyaz çinko kaplama, çift bilya yataklı, döner başlık, perçinli veya civatalı teker aksı
- 🔵 **Teker:** Poliamid kasa, PVC kaplama, jant kapaksız kendinden burçlu yataklı
- 🔵 **Bağlantı Tipleri:** Tabla bağlantılı, sabit bağlantılı, pim bağlantılı, civata bağlantılı

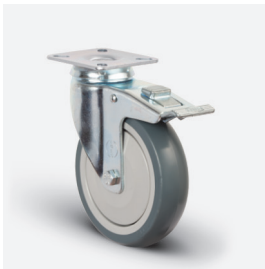

TEKER TİPLERİ





















Tabla Bağlantılı	 mm	 mm	 mm	 mm	 mm	 mm	 gr	 kg	
EP 01 ZKC 50	50	20	74	50x50	38x38	2	218	35	+
EP 01 ZKC 75	75	25	103	65x65	47x47	2	340	50	+



Tabla Bağlantılı, frenli	 mm	 mm	 mm	 mm	 mm	 mm	 gr	 kg	
EP 01 ZKC 50 F	50	20	74	50x50	38x38	2	245	35	+
EP 01 ZKC 75 F	75	25	103	65x65	47x47	2	385	50	+

EU SERİSİ

- 📦 Taşıma kapasitesi 55 Kg
- 🔧 **Maşa:** Preslenmiş çelik sac, beyaz çinko kaplama, çift bilya yataklı, döner başlık, perçinli veya civatalı teker aksı
- 🔸 **Teker:** Poliamid kasknak, PVC kaplama, jant kapaksız kendinden burçlu yataklı
- 🔸 **Bağlantı Tipleri:** Tabla bağlantılı, sabit bağlantılı, pim bağlantılı, civata bağlantılı



TEKER TİPLERİ





















Tabla Bağlantılı		 mm	 mm	 mm	 mm	 mm	 mm	 gr	 kg	
EU 01 ZKC	50	50	20	71	60x60	46x46	2	215	40	-
EU 01 ZKC	75	75	25	100	60x60	46x46	2	291	55	-



Tabla Bağlantılı, frenli		 mm	 mm	 mm	 mm	 mm	 mm	 gr	 kg	
EU 01 ZKC	50 F	50	20	71	60x60	46x46	2	265	40	-
EU 01 ZKC	75 F	75	25	100	60x60	46x46	2	345	55	-

ET SERİSİ

- 📦 Taşıma kapasitesi 80 Kg
- 🔧 **Maşa:** Preslenmiş çelik sac, beyaz çinko kaplama, çift bilya yataklı, döner başlık, perçinli veya civatalı teker aksı
- 🔸 **Teker:** Poliamid kasnak, PVC kaplama, jant kapaksız, kendinden burçlu yataklı, çift teker
- 🔸 **Bağlantı Tipleri:** Tabla bağlantılı, sabit bağlantılı, pim bağlantılı, civata bağlantılı



TEKER TİPLERİ





















Tabla Bağlantılı	 mm	 mm	 mm	 mm	 mm	 mm	 gr	 kg	
ET 01 ZKC 50	50	2x20	77	65x65	47x47	2	313	55	-
ET 01 ZKC 75	75	2x25	101	78x68	56x46	2,5	610	80	+



Tabla Bağlantılı, frenli	 mm	 mm	 mm	 mm	 mm	 mm	 gr	 kg	
ET 01 ZKC 50 F	50	2x20	77	65x65	47x47	2	369	55	-
ET 01 ZKC 75 F	75	2x25	101	78x68	56x46	2,5	655	80	+

EF SERİSİ

- 📦 Taşıma kapasitesi 55 Kg
- 🔧 **Maşa:** Preslenmiş çelik sac, krom kaplama, çift sıra bilya yataklı, döner başlık, perçinli teker aksı
- 🔸 **Teker:** Polipropilen kaskak, PVC kaplama, kendinden burçlu yataklı
- 🔸 **Bağlantı Tipleri:** Tabla bağlantılı, civata bağlantılı



Tabla Bağlantılı	Ø mm	mm	mm	mm	mm	mm	gr	kg	🔸
EF 01 MKC 40	40	35	56	42x40	30x28	1,5	141	40	-
EF 01 MKC 50	50	45	73	50x50	38x38	2	276	55	-



Pim bağlantılı	Ø mm	mm	mm	mm	mm	mm	gr	kg	🔸
EF 05 MKC 40	40	35	61	M10 - 3/8	16	1,5	140	40	-
EF 05 MKC 50	50	45	77	M10 - 3/8	16	2	249	55	-



Emes Endüstriyel Makine
Ekipmanları San. ve Tic. A.Ş

+90 216 304 06 79



+90 216 309 91 48



info@emesteker.com



www.emesteker.com



Orta Mah. 30 Ağustos Cad. No:61 34956 Orhanlı – Tuzla, İstanbul/Türkiye